



# Defence Technology Agency Composites Research

Ben Withy

FAA/CAANZ Composite Safety  
Meeting and Workshop

Wellington, NZ, 2-3 March 2016

*“The innovative application of science and technology enabling the NZDF to secure and protect New Zealand and its interests”*

# DTA Structure

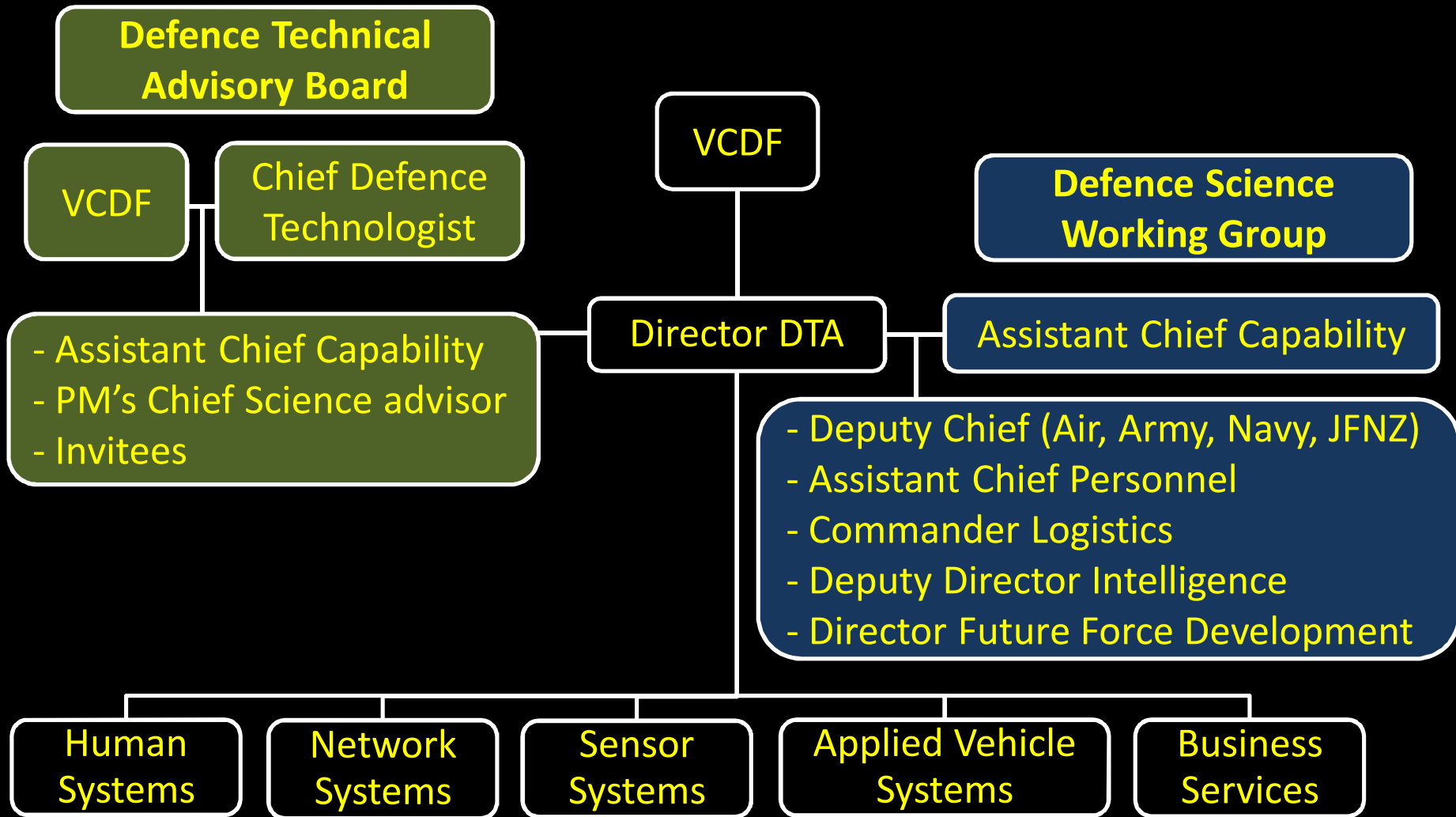

## Main DTA Programme Areas

### Force Protection

- “ Chemical, Biological and Radiological Defence
- “ Platform Defence (above and below water, sea, land and air platforms, conventional, fast inshore attack craft and asymmetric threats)
- “ Ballistic Protection for Personnel

### Through Life Support

- “ Military Platform Structures (materials, structures, engineering, corrosion, composites)
- “ Military Logistics (oils, HSNO, power systems)
- “ Weapon Effects (Counter IED, Less Lethal Weapons)

### Human Systems

- “ Human Performance
- “ Ergonomics
- “ Cognitive Performance
- “ Physical Enhancement
- “ Human Systems Integration
- “ Training Simulation

### Network Force Development

- “ Command and Control (C2)
- “ Networks and Communications
- “ Intelligence, Surveillance & Reconnaissance (ISR)
- “ Environmental Assessment
- “ Autonomous Military Systems
- “ Information Assurance

### Structural & Capability Analysis

- “ Operational Analysis (OA)
- “ Operational Research (OR)
- “ Simulation
- “ Experimentation

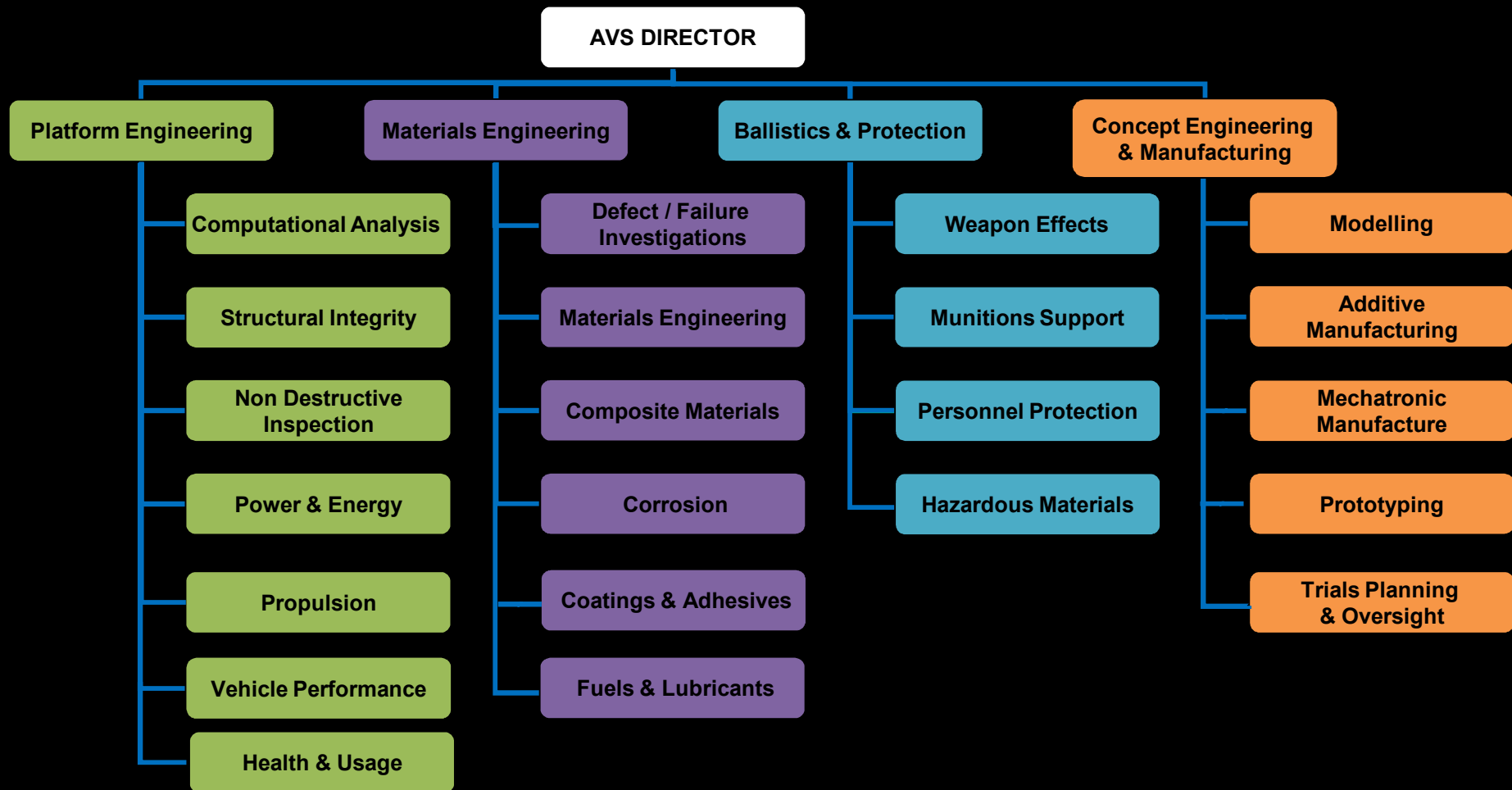



Defence Technology Agency

# Aviation Related Projects

Composite Repair Statistical Analysis

Composite Fatigue

Additive Manufacture Components Fatigue Properties

Sea Sprite Stores Clearance

Finite Element Analysis of Composites

Green ship / Green Fleet & Bio Fuels

Ballistics and Protection

Non-Chromate Primers

Composite Material Paint Removal Techniques

Composite Material NDI (Thermography)

Infrared Engine Inspection

- “ IANZ Accreditation
- “ Scanning Electron Microscope & Energy Dispersive Spectroscopy
- “ High Speed Camera
- “ Static and Dynamic Instron Test Machines
- “ Composites Workshop
- “ Environmental Chamber
- “ Chemical Laboratory
- “ Fuel Laboratory
- “ Hardness Testing Laboratory
- “ Additive Manufacture Printers / 3D Printers
- “ Optical Laboratory
- “ Specialist Test Equipment
- “ Metal Work & Machine Shop
- “ Infrared Camera
- “ Airborne Data Logger

## Collaboration and Research Partners

TTCP, ABCA, ABCANZ, NATO, 5-Eyes, Bilateral Agreements ( e.g. DSTO)

Academia (AUT, Massey, Canterbury, Auckland, Otago Universities)

Crown Research Organisation's, Government Organisations (e.g. ESIR, Police, TAIC)

CAA





- **Micro Scan Computed Tomography**
  - Tool for characterisation of composite laminates.
  - Assess quality of laminate and identify damage.
  - Export scans for FEA.
- **Digital Image Correlation**
  - Scanning for weakened and delaminated bond lines.
- **Epoxy Matrix Degradation**
  - Effects of aerospace fluids trialed. DGME FSII in F34 fuel no particularly degenerative. Further trial underway.
- **Protecting Sandwich Panels from Impact and Abrasion**
  - Use of 'composite' protection schemes to protect helicopter interiors.
- **Surface Preparation Effects**
  - Compare static capacity and durability of bond lines with different surface preparation techniques.

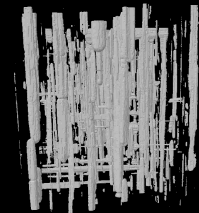
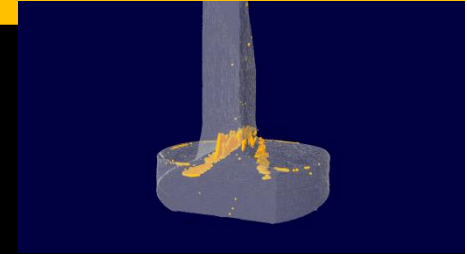

- **Failure Analysis**
  - Secondment of one researcher to DSTO in addition to in house 'database' building.
  
- **Manufacturing Method Comparison**
  - Quantify difference in performance of laminates manufactured using different techniques (autoclave vs vacuum bag, compaction vs no compaction, UD vs cloth, thick vs thin, etc).
  
- **Analysis Methods**
  - Damage modeling and prediction.
  - Failure prediction.
  - Repair design.
  - XFEM.
  - Probabilistic analysis.

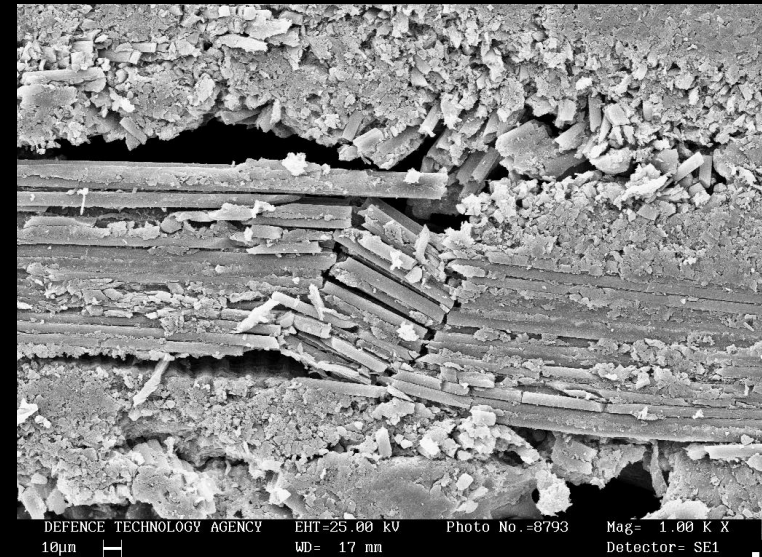

# Recent DTA Research

- **GasTOPS FilterCHECK acquired.**
  - Tool for quantifying and identifying particles in system filters.
  - Allows wear debris to be trended and failure predicted.
  - Database of wear behavior developed in collaboration.
- **RB211 engine filters checked prior to first Antarctic B757 flight.**
  - Excessive particles found for one engine indicating imminent bearing failure.
  - Engine changed before flight and fault subsequently confirmed.
- **Payback**
  - \$300,000 USD bearing replacement in lieu of \$3 million USD engine repair if flight had proceeded and failure had occurred.
  - RNZAF avoided engine failure in Antarctica with associated safety and logistical risks.

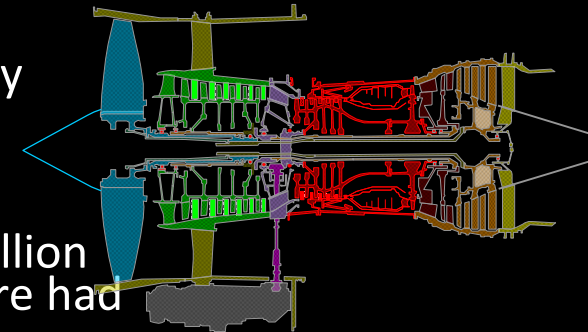

- Life extension programme almost completed on RNZAF C130 fleet, including hole cold work programme on wing planks.
- Study completed of stress field about cold worked holes in ¼" 7075-T6 representative of C130 wing planks.
- Fatigue test programme completed, validating stress field findings of modeling.
- Fatigue test programme initiated for effects of corrosion in concert with cold worked holes to determine effect of in service corrosion on the benefit provided by cold working.

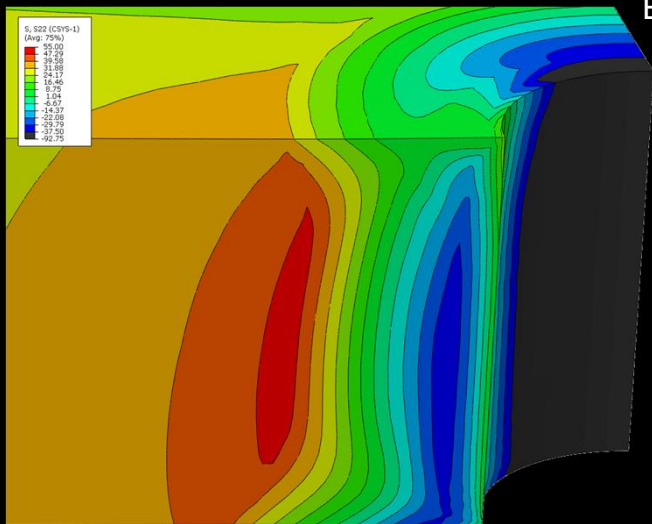

Entry face with low residual compressive field and crack initiation



- “ Compression strength after impact damage and repair scheme evaluation on composite panels (ASTM D 7137)
- “ Flash thermography to detect damage in composite skins
- “ Three dimensional large field strain evaluation through digital image correlation
- “ Fatigue performance of NH90 materials and bonded and bolted joints for repair evaluation



- Date 22 Aug 13
- Time 1600
- Temp 6 Deg C
- Nil Icing
- Moderate Turbulence
- Nil SIGMET in force in intended area of Op's.

- “ All Crew – Very loud bang
- “ Pilots – Bright flash of light
- “ Pilot – Observed a momentary fluctuation in rotor RPM
- “ All Crew – Faint burning smell
- “ Nil Warnings, cautions or new degradations to avionics systems
- “ Temp and Press remained stable and in the ‘Green’
- “ Slight increase in vibration along with faint whistling sound
- “ Helicopter remained stable and controllable
- “ Visible damage to MRB/TRB post shutdown
- “ Strike to Landing : 6-8 minute flight time

- “ Immediate Evidence of Lightning Strike
  - “ MRB: All blades exhibited some degree of external damage (typically burn marks)
  - “ TRB: Black Blade damaged (tip area), remaining blades visually undamaged
  - “ Fuselage (incl Bonding Points): Nil indications of external damage
  - “ General: Some examples of localised arcing or heat spots over the electrical path, i.e. Leading Edge Strips, MRH and IGB Mounts
  - “ Avionic Bays: Nil indications of associated damage
  - “ Electrical Power Supply Test and Hydraulic Power Operational Test completed without fault



## TRB: Black Blade

- " Zone A . Burn markings (penetration)
- " Zone B . Rupture of trailing edge
- " Zone C . Arcing across leading edge strip

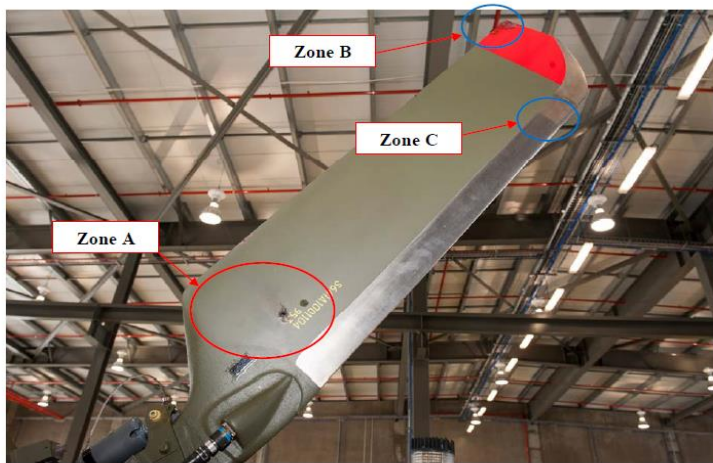

FIGURE 1



FIGURE 2

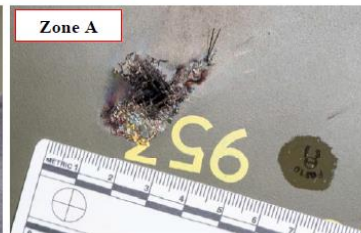

FIGURE 3

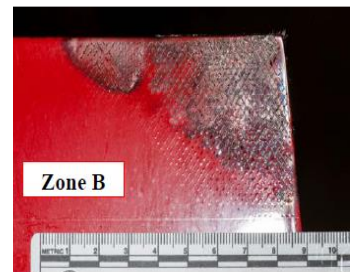

FIGURE 4

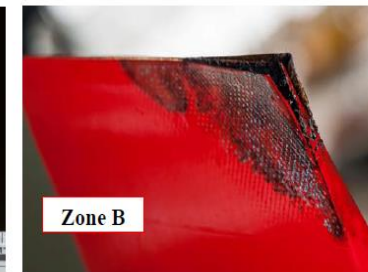

FIGURE 5

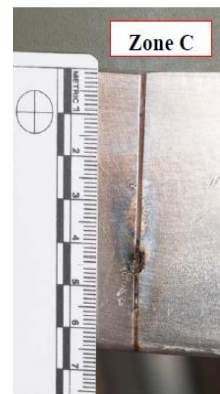
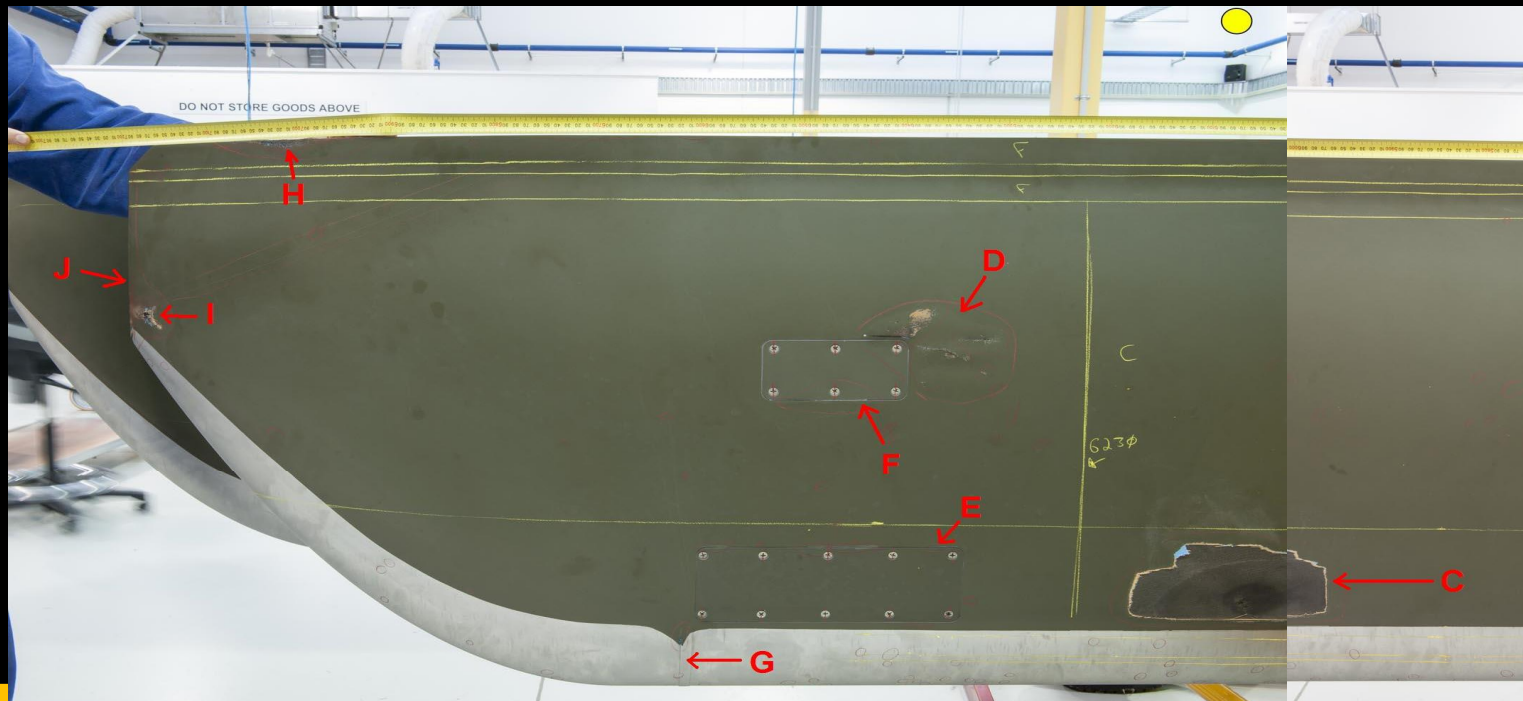

FIGURE 6

## MRB (yellow): Top Side

- " Area C . Large surface rupture with associated burn marking
- " Area D . Multiple blistering/delamination, concentration of heating effects
- " Area H . Rupture of trailing edge
- " Area I . Localised heating effects, penetration.





# Inspection Results

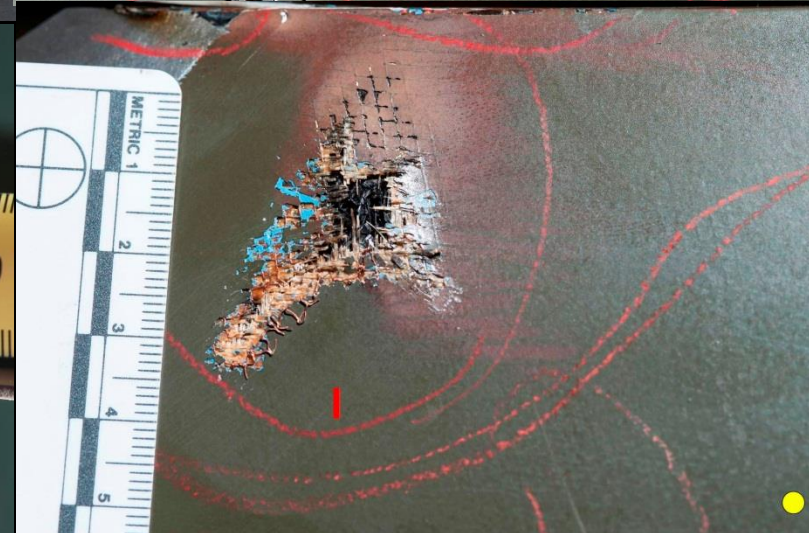
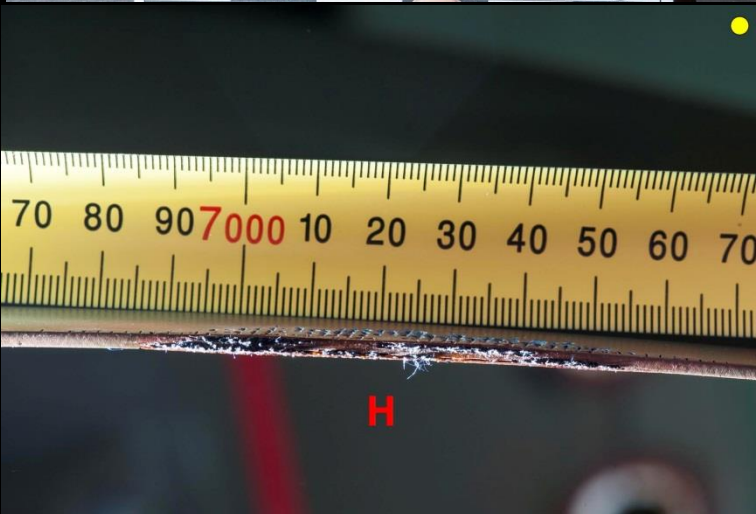
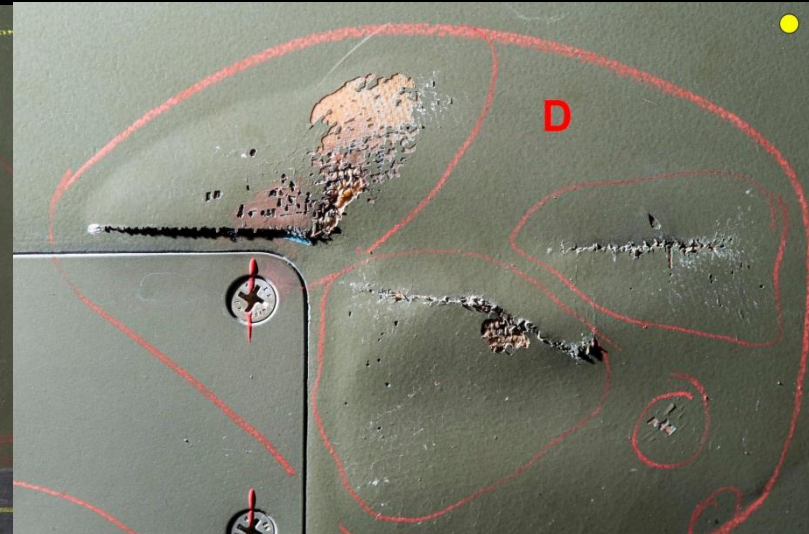

# Inspection Results

- “ MRB (yellow): Lower Side
  - “ Areas M/N/O - Localised blistering, burning, delamination
  - “ Areas Q/R/S . Localised heating effects, penetration
  - “ Area T . Melting/erosion to expose composite weave
  - “ Area X . Tip light rupture
- “ Some route damage on other MRB§

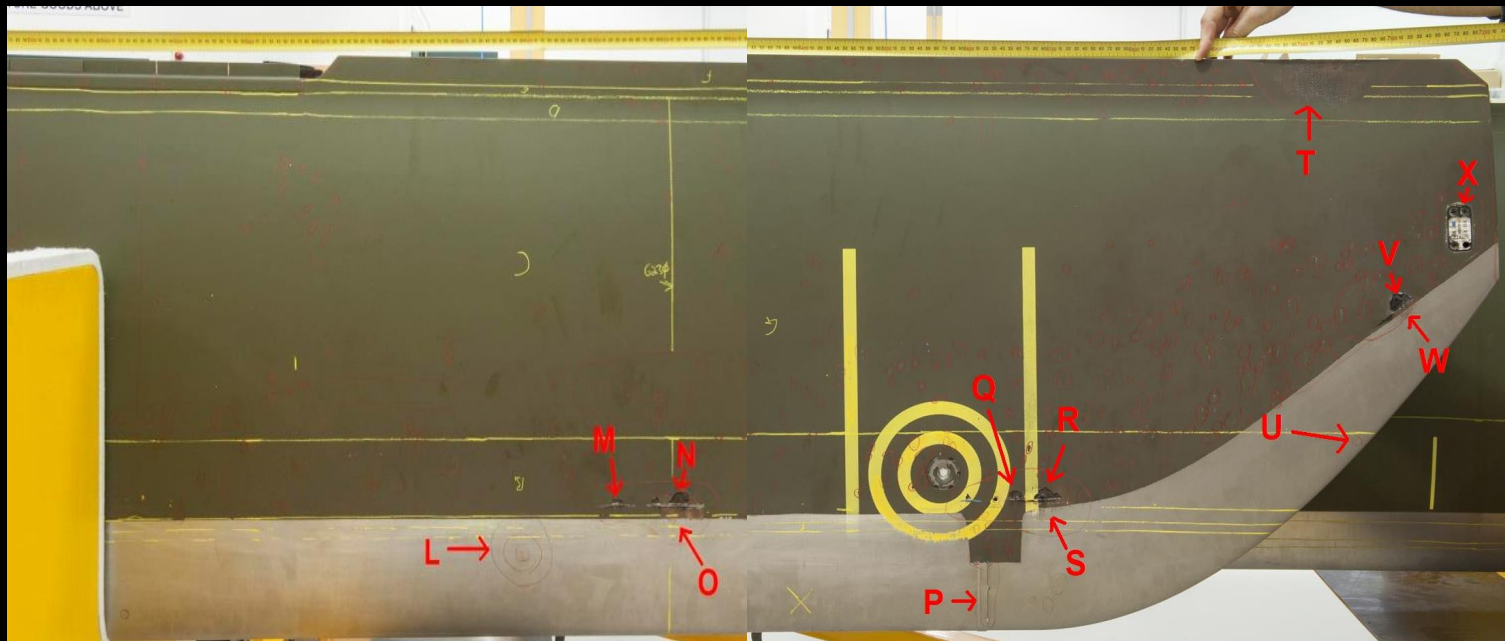



# Inspection Results

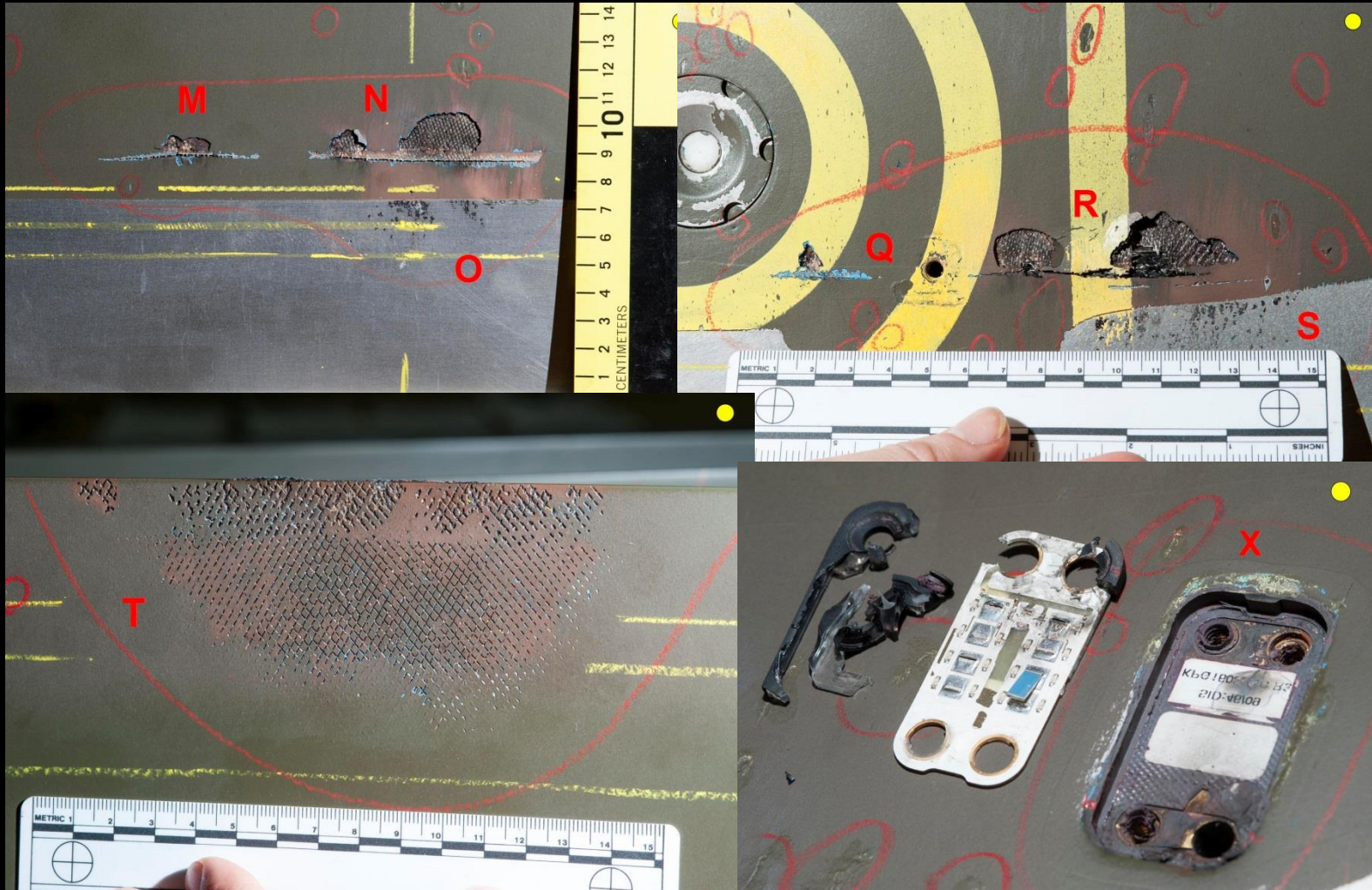

# Inspection Results





# Inspection Results

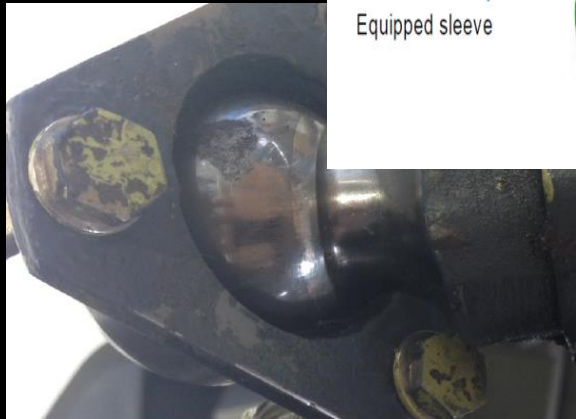
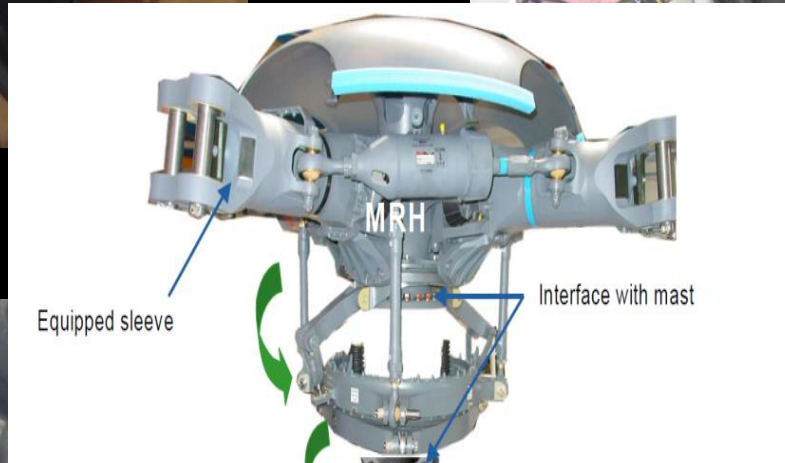
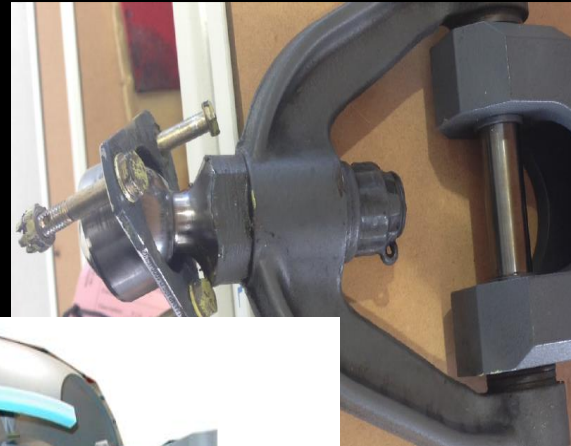

# Inspection Results

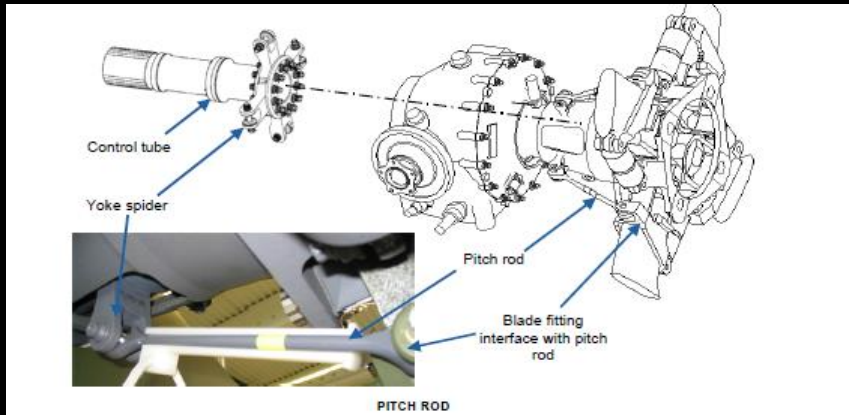



# Possible Path



dta

Defence Technology Agency



Questions?